

PKC46DY

Dual N-Channel Enhancement Mode MOSFET

PRODUCT SUMMARY

$V_{(BR)DSS}$	$R_{DS(ON)}$	I_D	CH.
30V	1.9m Ω @ $V_{GS} = 10V$	99A	Q2
30V	9.5m Ω @ $V_{GS} = 10V$	34A	Q1

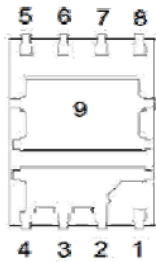
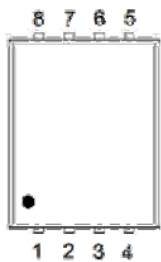

1 : G1
2,3,4 : D1
5,6,7 : S2
8 : G2
9 : S1/D2

PDFN 5*6P

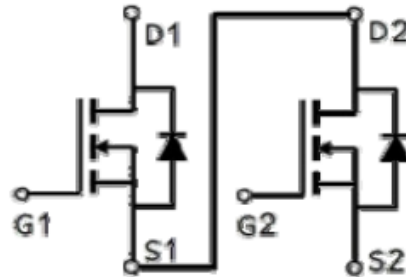

ABSOLUTE MAXIMUM RATINGS ($T_A = 25\text{ }^\circ\text{C}$ Unless Otherwise Noted)

PARAMETERS/TEST CONDITIONS		SYMBOL	CH.	LIMITS	UNITS
Drain-Source Voltage		V_{DS}	Q2	30	V
			Q1	30	
Gate-Source Voltage		V_{GS}	Q2	± 20	V
			Q1	± 20	
Continuous Drain Current ³	$T_C = 25\text{ }^\circ\text{C}$	I_D	Q2	99	A
			Q1	34	
	$T_C = 100\text{ }^\circ\text{C}$		Q2	63	
			Q1	21	
Pulsed Drain Current ¹		I_{DM}	Q2	150	A
			Q1	70	
Continuous Drain Current	$T_A = 25\text{ }^\circ\text{C}$	I_D	Q2	25	A
			Q1	9.2	
	$T_A = 70\text{ }^\circ\text{C}$		Q2	20	
			Q1	7.3	
Avalanche Current		I_{AS}	Q2	52	A
			Q1	22	
Avalanche Energy	$L = 0.1\text{mH}$	E_{AS}	Q2	135	mJ
			Q1	24	
Power Dissipation	$T_C = 25\text{ }^\circ\text{C}$	P_D	Q2	36	W
			Q1	24	
	$T_C = 100\text{ }^\circ\text{C}$		Q2	14.7	
			Q1	9.6	

PKC46DY

Dual N-Channel Enhancement Mode MOSFET

Power Dissipation	$T_A = 25\text{ }^\circ\text{C}$	P_D	Q2	2.4	W
	$T_A = 70\text{ }^\circ\text{C}$		Q1	1.7	
			Q2	1.5	
	Q1		1.1		
Operating Junction & Storage Temperature Range		T_J, T_{STG}	-55 to 150		$^\circ\text{C}$

THERMAL RESISTANCE RATINGS

THERMAL RESISTANCE	SYMBOL	CH.	TYPICAL	MAXIMUM	UNITS
Junction-to-Ambient ²	$R_{\theta JA}$	Q2		52	$^\circ\text{C} / \text{W}$
		Q1		72	
Junction-to-Case	$R_{\theta JC}$	Q2		3.4	
		Q1		5.2	

¹Pulse width limited by maximum junction temperature $T_{J(\text{MAX})}=150^\circ\text{C}$.

²The value of $R_{\theta JA}$ is measured with the device mounted on 1in² FR-4 board with 2oz. Copper, in a still air environment with $T_A = 25^\circ\text{C}$. The value in any given application depends on the user's specific board design.

³Package limitation current :Q1=35A,Q2=35A.

ELECTRICAL CHARACTERISTICS ($T_J = 25\text{ }^\circ\text{C}$, Unless Otherwise Noted)

PARAMETER	SYMBOL	TEST CONDITIONS	CH.	LIMITS			UNITS
				MIN	TYP	MAX	
STATIC							
Drain-Source Breakdown Voltage	$V_{(BR)DSS}$	$V_{GS} = 0V, I_D = 250\mu\text{A}$	Q2	30			V
			Q1	30			
Gate Threshold Voltage	$V_{GS(th)}$	$V_{DS} = V_{GS}, I_D = 250\mu\text{A}$	Q2	1.3	1.75	2.3	V
			Q1	1.3	1.75	2.3	
Gate-Body Leakage	I_{GSS}	$V_{DS} = 0V, V_{GS} = \pm 20V$	Q2			± 100	nA
			Q1			± 100	
Zero Gate Voltage Drain Current	I_{DSS}	$V_{DS} = 24V, V_{GS} = 0V$	Q2			1	μA
			Q1			1	
		$V_{DS} = 20V, V_{GS} = 0V, T_J = 55\text{ }^\circ\text{C}$	Q2			10	
			Q1			10	
Drain-Source On-State Resistance ¹	$R_{DS(ON)}$	$V_{GS} = 4.5V, I_D = 16A$	Q2		2.1	2.5	m Ω
		$V_{GS} = 4.5V, I_D = 13A$	Q1		10.5	14	
		$V_{GS} = 10V, I_D = 20A$	Q2		1.5	1.9	
		$V_{GS} = 10V, I_D = 13A$	Q1		6.7	9.5	
Forward Transconductance ¹	g_{fs}	$V_{DS} = 5V, I_D = 20A$	Q2		72		S
		$V_{DS} = 5V, I_D = 10A$	Q1		37		

PKC46DY

Dual N-Channel Enhancement Mode MOSFET

DYNAMIC						
Input Capacitance	C_{iss}	$V_{GS} = 0V,$ $V_{DS} = 15V, f = 1MHz$	Q2		2868	pF
Output Capacitance	C_{oss}		Q1		525	
			Q2		515	
Reverse Transfer Capacitance	C_{rss}		Q1		146	
			Q2		315	
Gate Resistance	R_g		Q1		70	
		Q2		1.1		
Gate Resistance	R_g	Q1		1.1	Ω	
		Q2		1.1		
Total Gate Charge ²	Q_g	$Q2$ $V_{DS} = 15V, I_D = 20A$ $Q1$ $V_{DS} = 15V, I_D = 13A$	$V_{GS}=10V$	Q2	56	nC
			$V_{GS}=4.5V$	Q1	10.5	
Gate-Source Charge ²	Q_{gs}		Q2		29	
			Q1		5.8	
Gate-Drain Charge ²	Q_{gd}		Q2		8.3	
			Q1		1.5	
Turn-On Delay Time ²	$t_{d(on)}$		Q2		14	nS
			Q1		3.1	
Rise Time ²	t_r		Q2		25	
			Q1		11	
Turn-Off Delay Time ²	$t_{d(off)}$		Q2		18	
			Q1		10	
Fall Time ²	t_f	Q2		54		
		Q1		7		
SOURCE-DRAIN DIODE RATINGS AND CHARACTERISTICS ($T_J = 25^\circ C$)						
Continuous Current ³	I_S		Q2		36	A
			Q1		20	
Forward Voltage ¹	V_{SD}	$I_F = 20A, V_{GS} = 0V$	Q2		1	V
		$I_F = 13A, V_{GS} = 0V$	Q1		1.2	
Reverse Recovery Time	t_{rr}	$Q2$ $I_F = 20A, di_F/dt = 100A/\mu S$	Q2		28	nS
			Q1		10	
Reverse Recovery Charge	Q_{rr}	$Q1$ $I_F = 13A, di_F/dt = 100A/\mu S$	Q2		12	nC
			Q1		2	

¹Pulse test : Pulse Width $\leq 300 \mu sec$, Duty Cycle $\leq 2\%$.

²Independent of operating temperature.

³Package limitation current :Q1=35A,Q2=35A.

PKC46DY

Dual N-Channel Enhancement Mode MOSFET

Q2

Output Characteristics

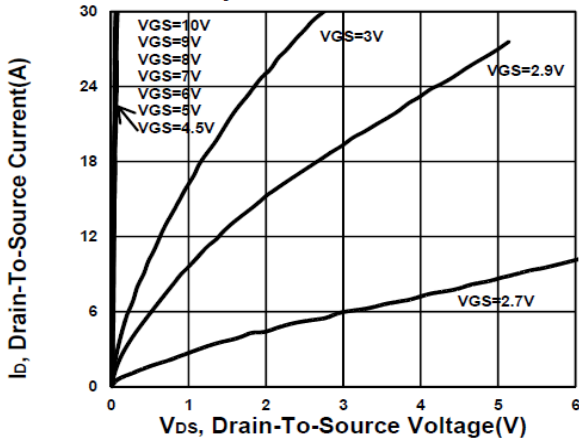

Transfer Characteristics

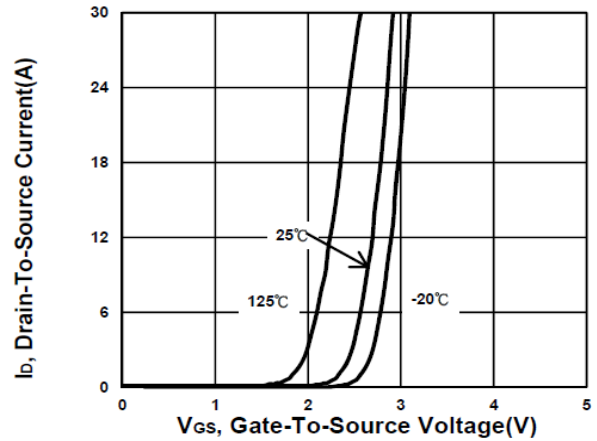

Gate charge Characteristics

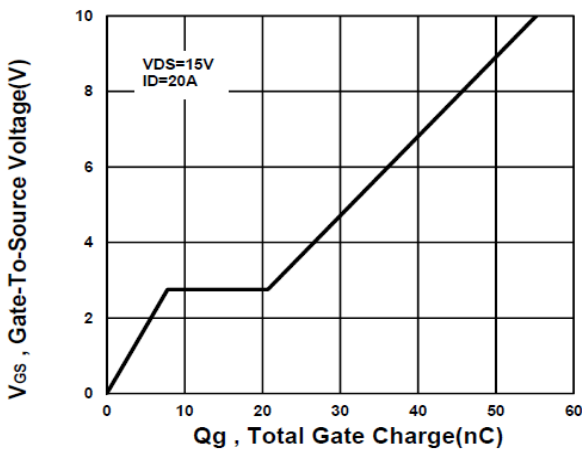

Capacitance Characteristic

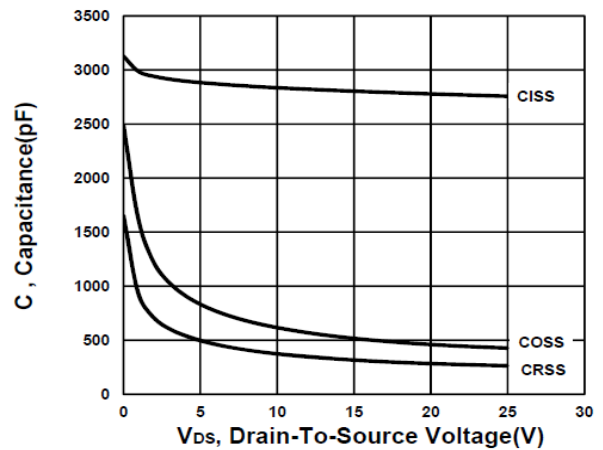

On-Resistance VS Gate-To-Source

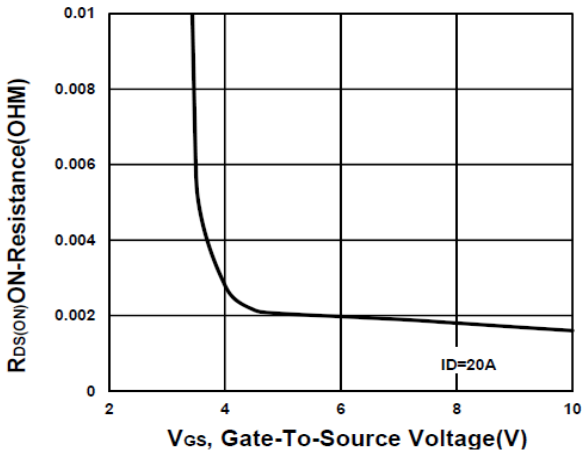

On-Resistance VS Drain Current

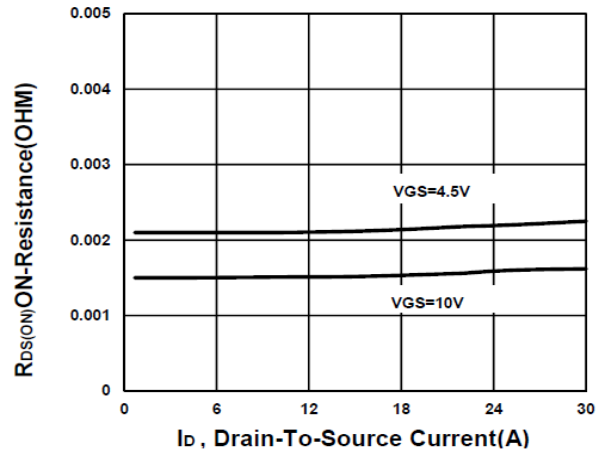

PKC46DY

Dual N-Channel Enhancement Mode MOSFET

On-Resistance VS Temperature

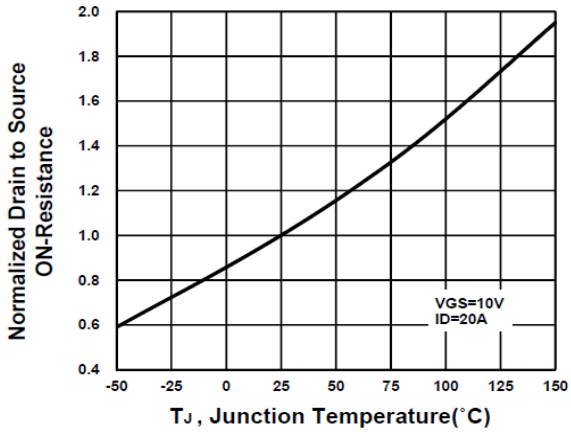

Source-Drain Diode Forward Voltage

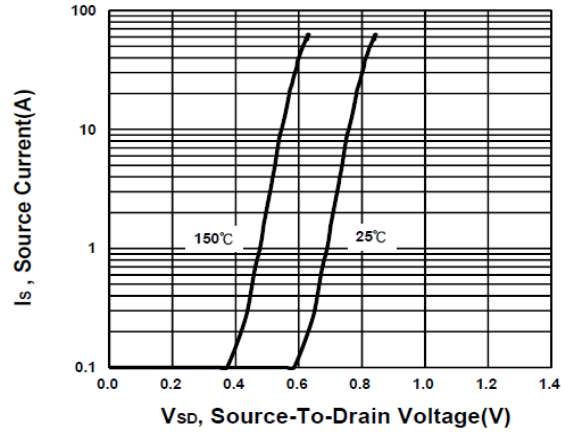

Safe Operating Area

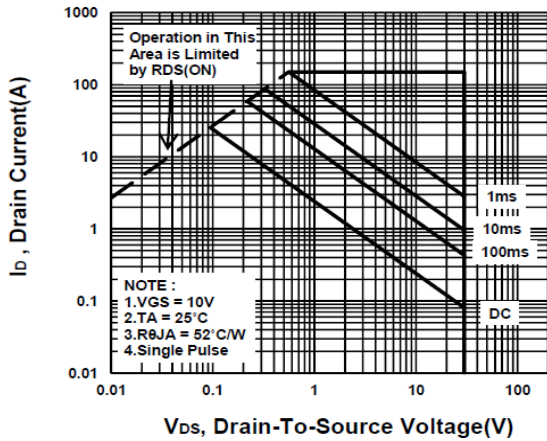

Single Pulse Maximum Power Dissipation

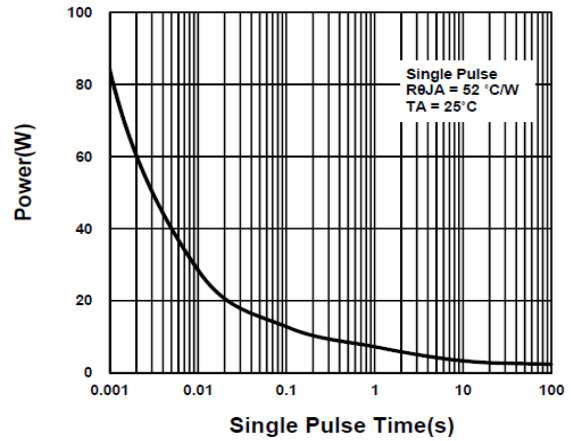

Transient Thermal Response Curve

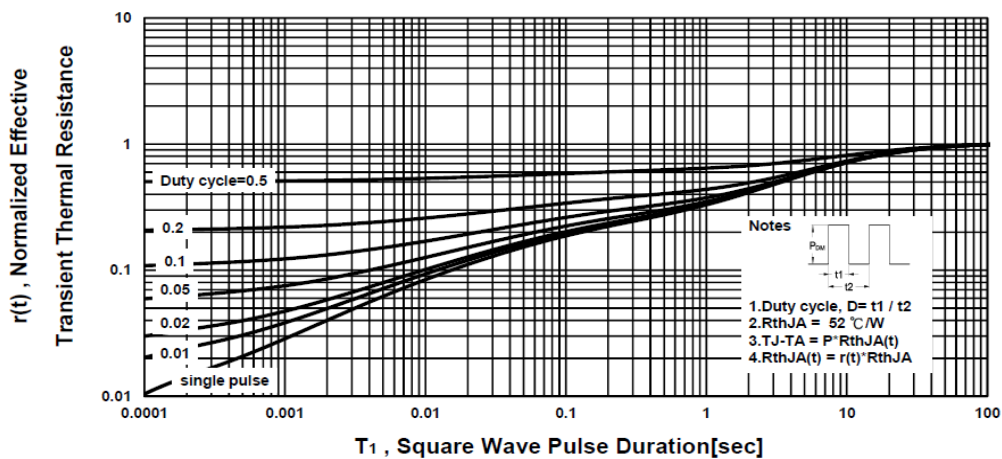

PKC46DY

Dual N-Channel Enhancement Mode MOSFET

Q1

Output Characteristics

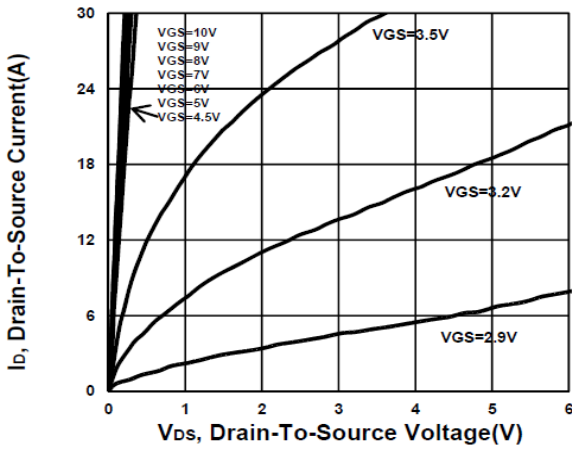

Transfer Characteristics

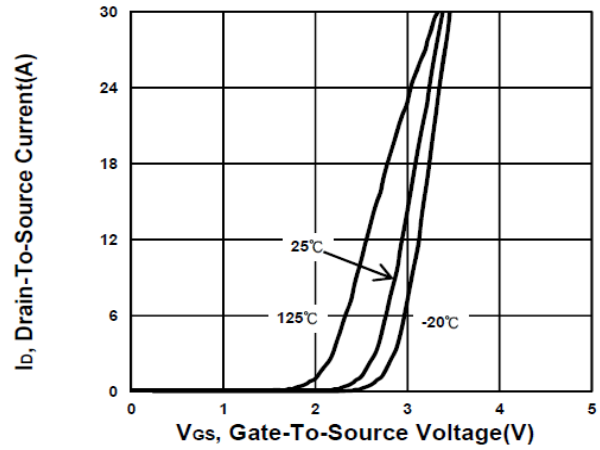

Gate charge Characteristics

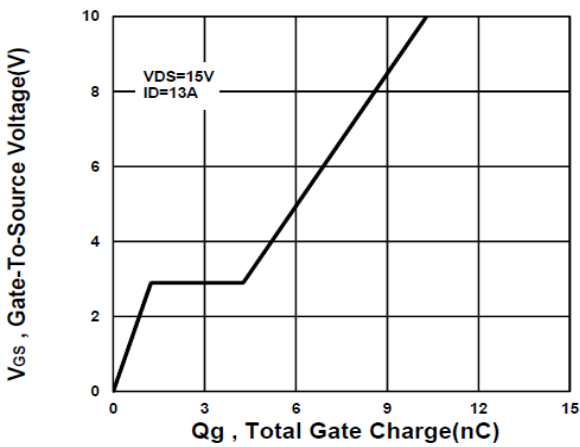

Capacitance Characteristic

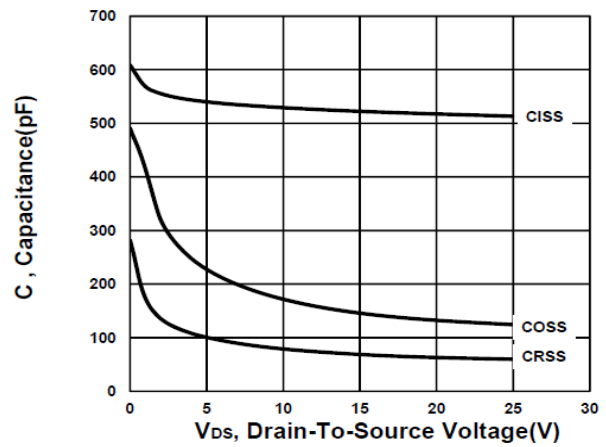

On-Resistance VS Gate-To-Source

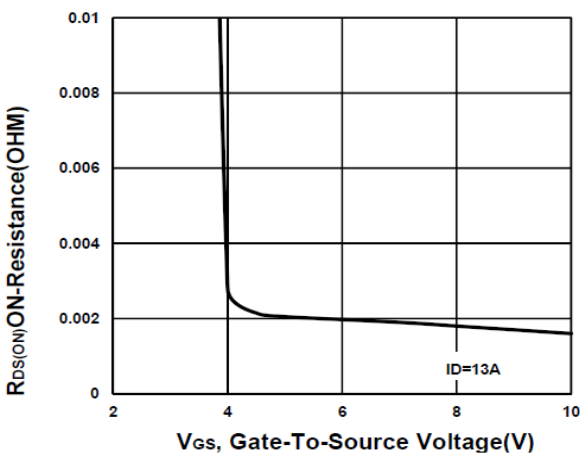

On-Resistance VS Drain Current

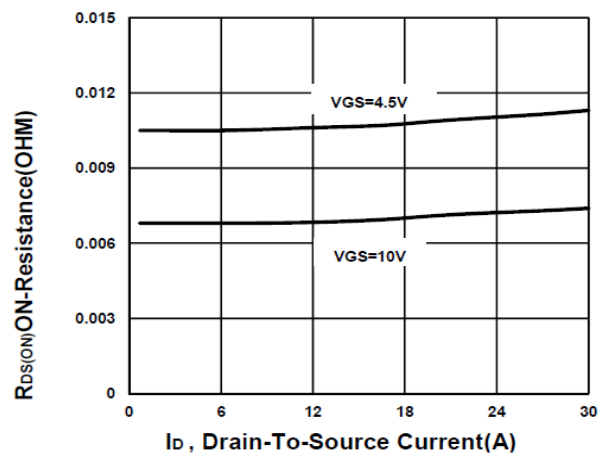

PKC46DY

Dual N-Channel Enhancement Mode MOSFET

On-Resistance VS Temperature

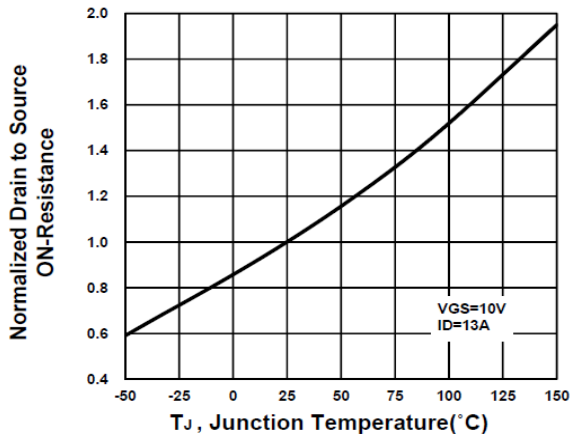

Source-Drain Diode Forward Voltage

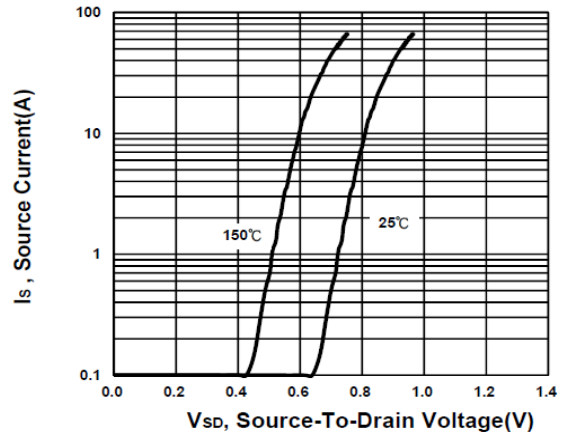

Safe Operating Area

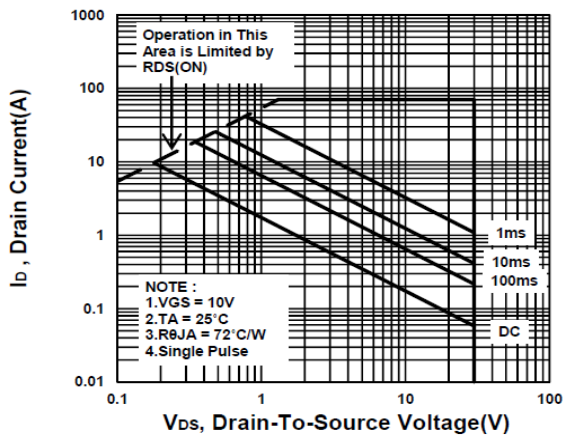

Single Pulse Maximum Power Dissipation

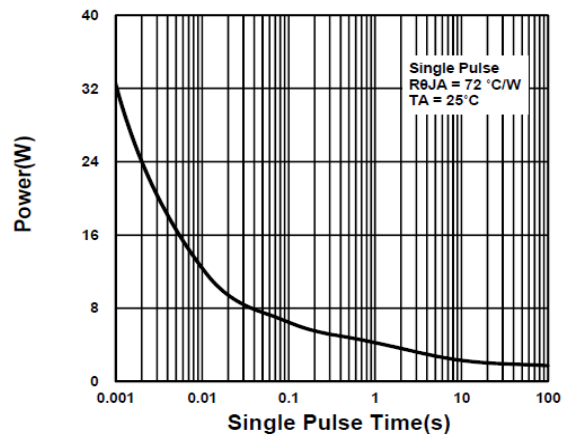

Transient Thermal Response Curve

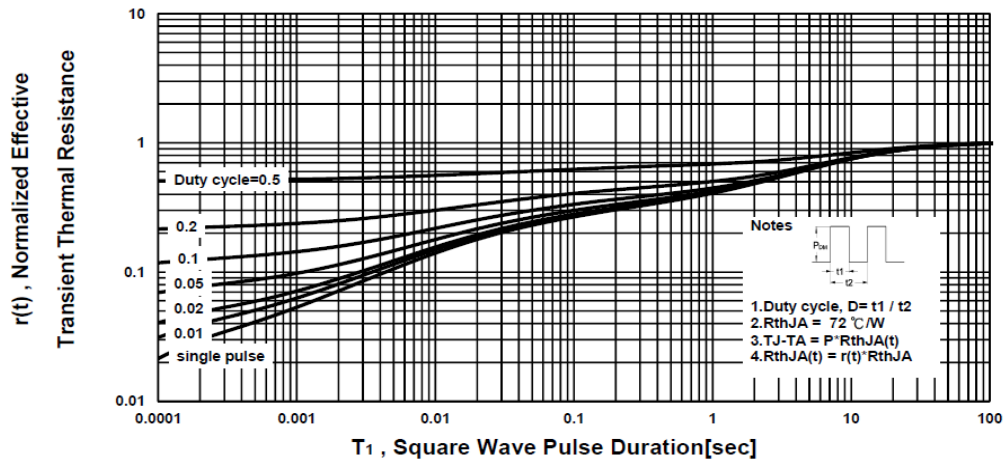

PKC46DY

Dual N-Channel Enhancement Mode MOSFET

Package Dimension

PDFN 5x6P(上下 Dual) MECHANICAL DATA

Dimension	mm			Dimension	mm		
	Min.	Typ.	Max.		Min.	Typ.	Max.
A	4.8	5	5.4	K	0.82	1.06	1.3
B	5.9	6.15	6.35	L	0.4	0.5	0.6
C	0.9	1	1.18	M	2.0	2.21	2.42
D	5.42	5.59	5.85	N	0.5	1	
E	0.15	0.25	0.35	O	0.42	0.56	0.71
F	0°	6°	12°	P	0.3	0.4	0.51
G	1.17	1.27	1.37	Q	3.61	4.05	4.5
H	0.06	0.21	0.36				
J	0.41	0.55	0.7				

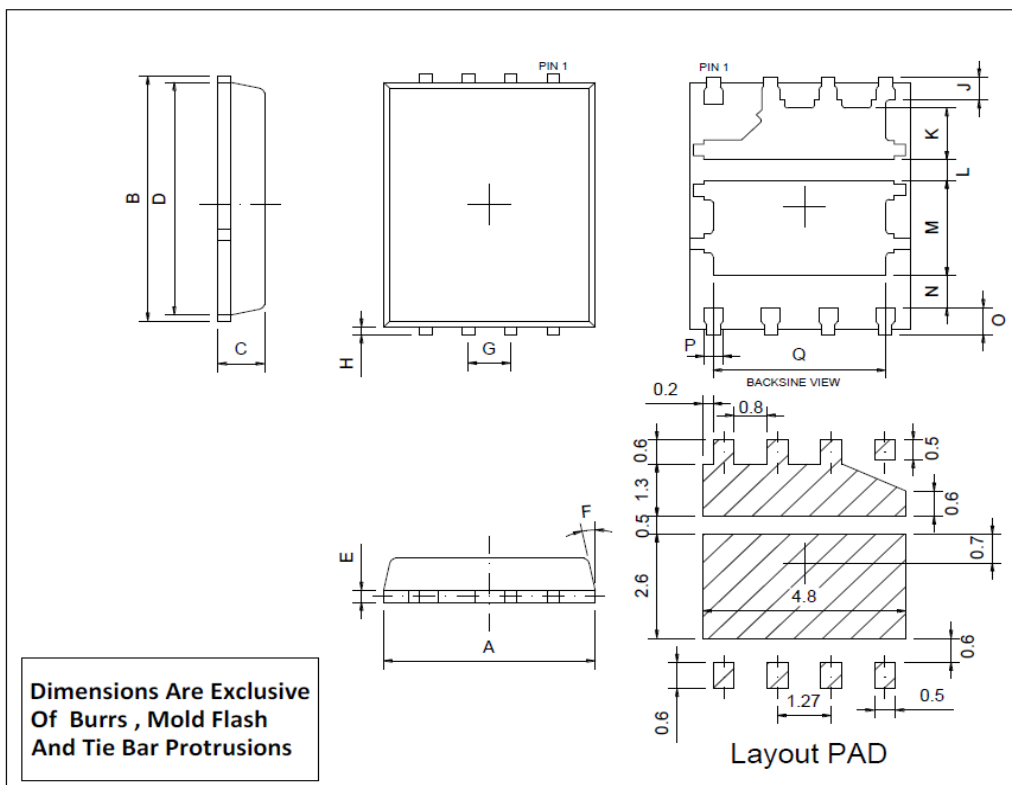

* 散热片形状会因为封装厂框架不同而有所差异。

PKC46DY

Dual N-Channel Enhancement Mode MOSFET

A. Marking Information

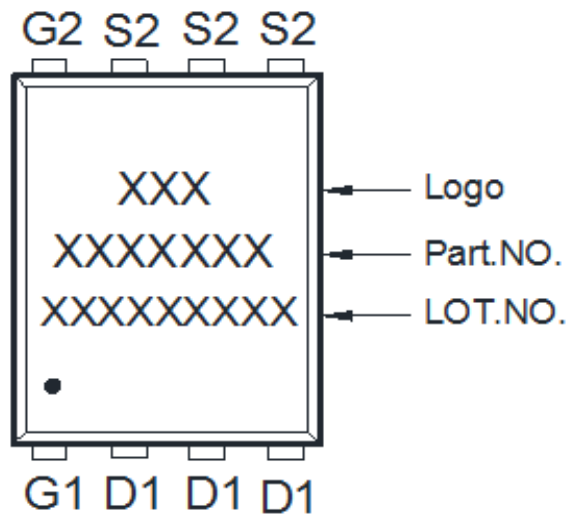

B. Tape & Reel Information: 3000pcs/Reel

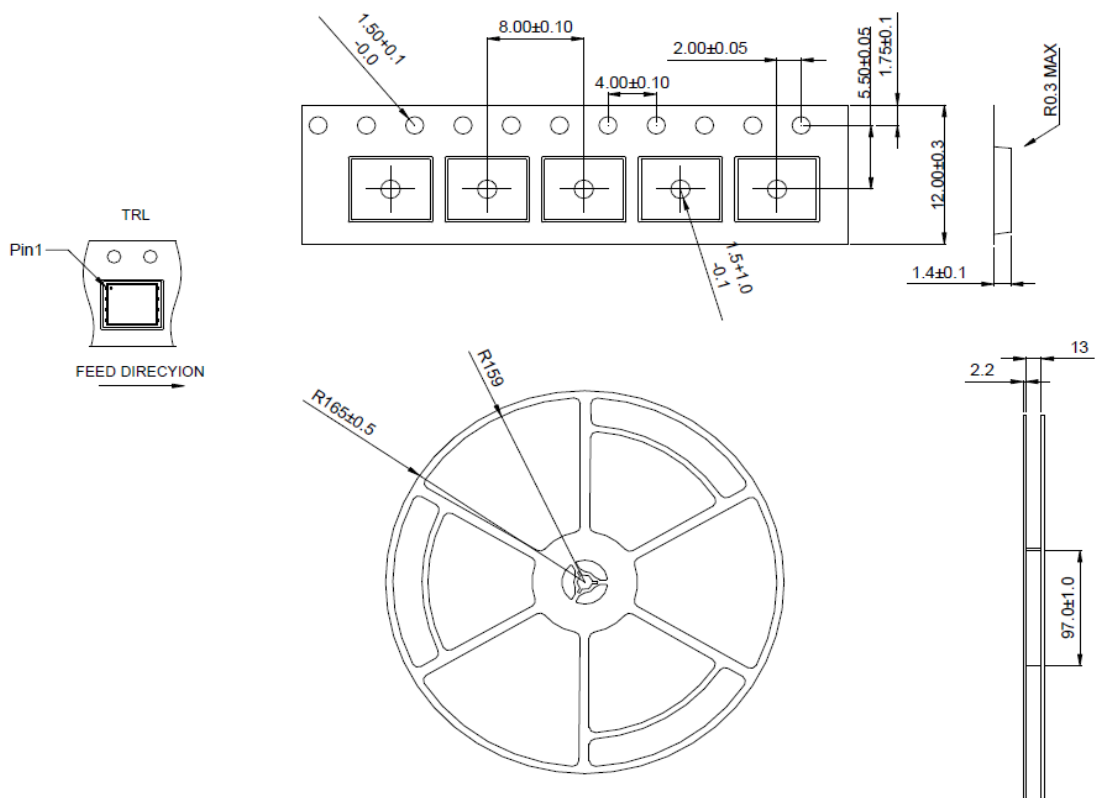

PKC46DY

Dual N-Channel Enhancement Mode MOSFET

C. Lot No.&Date Code rule

1.Lot No.

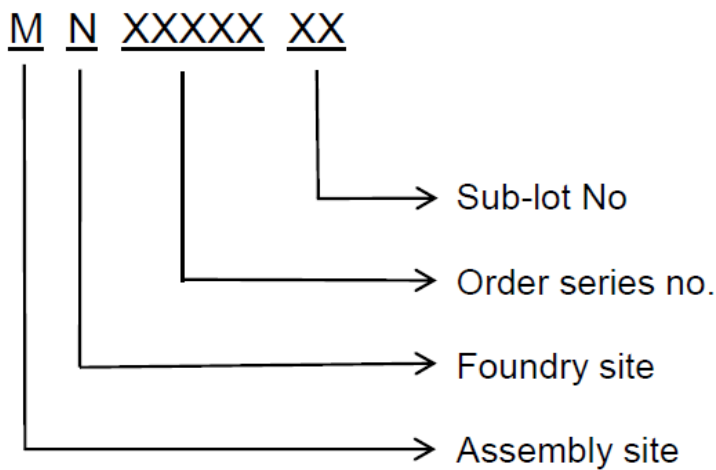

2.Date Code

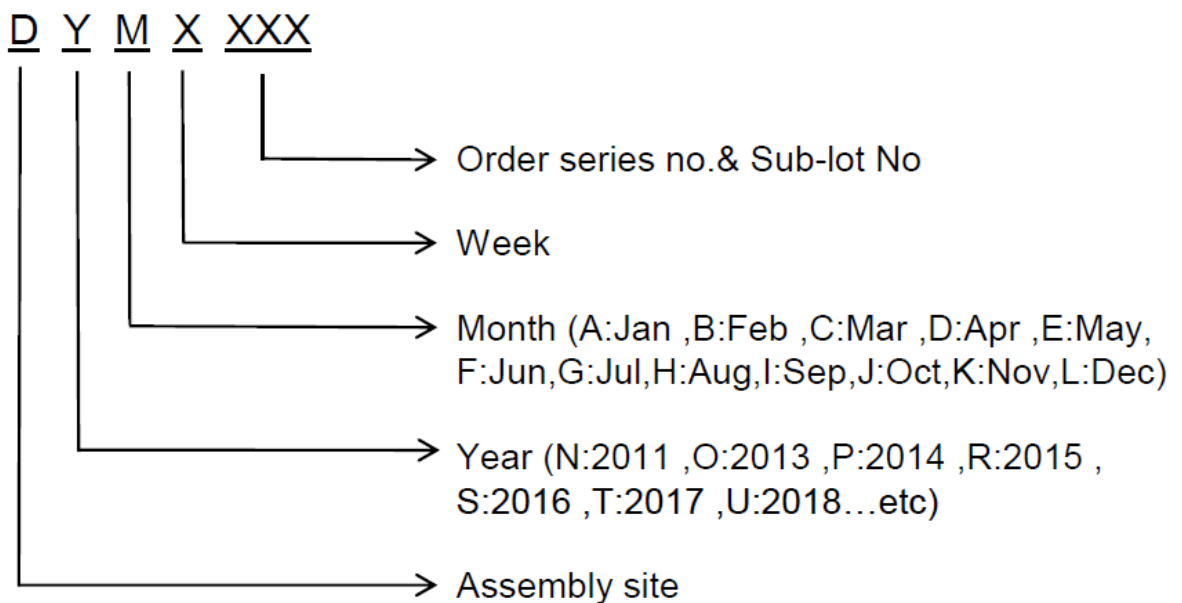



PKC46DY

Dual N-Channel Enhancement Mode MOSFET

D.Label rule

标签内容(Label content)



1	Label Size	30 * 90 mm
2	Font style	Times New Roman or Arial (或可区分英文”0”和数字”0”，”G和”Q”的字型即可)
3	U-NIKC	Height: 4 mm
4	Package	Height: 2 mm
5	Date	Height: 2 mm Shipping date: YYYY/MM/DD, ex. 2008/09/12
6	Device	Height: 3 mm (Max: 16 Digit)
7	Lot	Height: 3 mm (Max: 9 Digit) Sub lot
8	D/C	Height: 3 mm (Max: 7 Digit)
9	QTY	Height: 3 mm (Max: 6 Digit) Thousand mark is no needed
10	RoHS label	 long axis: 12 mm minor axis:6 mm bottom color: White Font color: Black Font style: Arial
11	Halogen Free label	 Diameter: 10 mm bottom color: Green Font color: Black Font style: Arial
12	Scan information	Device / Lot / D/C / QTY , Insert “ / “ between every parts. for example: P3055LDG/G12345601/GGG2301/2000 DPI (Dots per inch): Over 300 dpi Code : Code 128 Height: 6 mm at least